

Oil-Free Scroll Air Compressor	DATE	17-0105
	CUSTOMER	
	MODEL No.	SLPS-150B
1. BASIC COMP.		
Air end	SL-165E x 4 unit	
Compressed fluid	Atmosphere (air)	
Compressed method	Oil free scroll	
Cooling method	Air cooled	
Operation control	Multi stage control Automatic start-stop [Pressure sensor detect]	
Installation requirements	In door	
Suction requirements	Atmospheric pressure , 0~40℃	
Control pressure	0.65 ~ 0.8 MPa	
Free air delivery ※1	1,680 L/min	
Air end rotation speed	3,150 min-1	
Driving method	V-Belt Driven	
Discharge air outlet	Rc 1	
Air Receiver	Not being equipped with unit	
Discharge outlet temperature	Suction air temperature less than +35℃	
Noise level (1.5m from the front) ※2	58 dB(A)	
Ground vibration ※3 dB	Lower than 45	
Panel vibration (half amplitude) μm	Lower than 150	
2. MOTOR		
Type of motor	F Class insulation 4 pole	
Output power	15 kW	
Electric source	Three phase AC 220, 380, 440V / 60Hz	
Rated current (60Hz)	220V : 53.6A 380V : 32.0A 440V : 26.8A	
Starter method	Magnetic contactor direct start (Sequential start)	
3. PROTECTION		
Over current stop	Thermal Relay (OCR)	
Air end over heat stop	Advance alarm	
4. OTHERS		
Dimension (L x W x H) ※5	718 x 1,140 x 1,640 mm	
Approx. weight	510 kg	
External control signal input contact	Operation circuit 220V	
Malfunction Alarm signal Output contact	Non current "a" contact point	
Accessories	Instruction manual , Anchor stay x 4, Bolt x 8	

REMARK

- ※1. Air delivery is discharged air volume at 0.8MPa converted into atmospheric pressure.
(all air end in operation)
- ※2. Noise level is measured at an anechoic room under loading operation.
- ※3. The ground vibration is measured at the distance of 10cm from the front.
(The vibration value varies subject to ground situation.)
The data is for reference when it is commissioned on a concrete floor.
- ※4. The dimension is outer size excluding ball valve.

- Notice :
1. Please set the compressor on the flat floor.
 2. Please be sure to set it on indoors.
 3. If you install it in the small room, the room temperature will rise.
If the room temperature is over 40°C, please set the exhaust duct or ventilating fan.
 4. Please be sure to consider the space of maintenance, piping, and ventilation.
(Front : 600mm, Right, Left, Rear : Over 700mm, Roof : 1200mm and more)
 5. In case of electric wiring, please see the instruction manual.

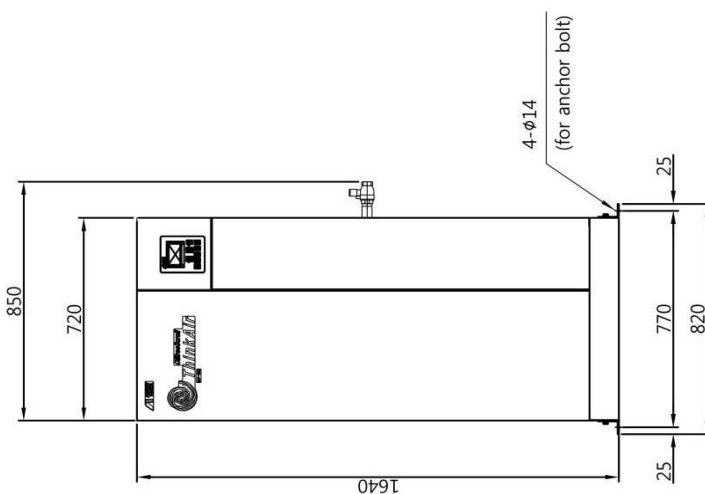
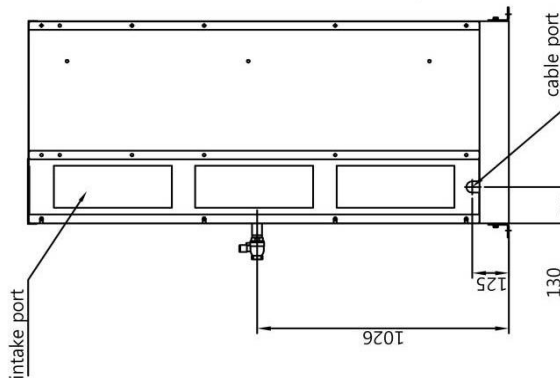
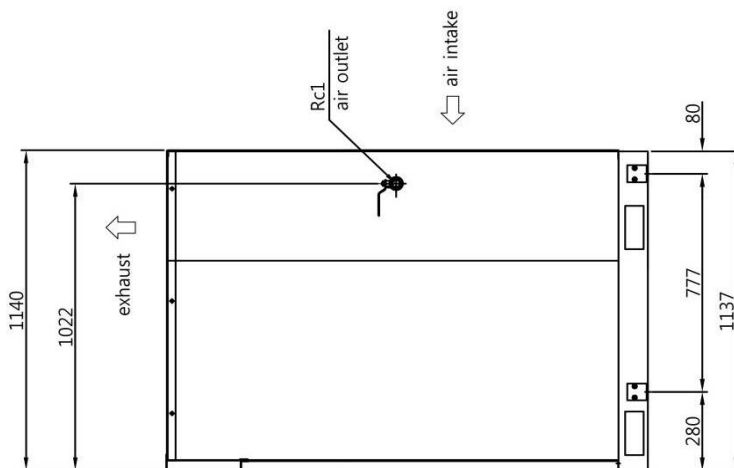
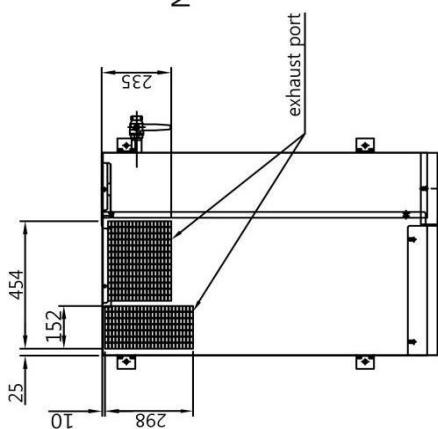

Product Name

Oil-Free Scroll Air Compressor

Model

SLPS-150B

REV. 0

- 주의 : 1. 압축기는 바닥이 평평한 장소에 설치하여 주십시오.
 2. 반드시 실내에 설치하여 주십시오.
 3. 공냉식으로 좁은 공간에 설치할 경우 주위온도가 상승합니다.
 주위온도가 40°C 이상인 경우, 반드시 덕트, 환기팬을 설치하여 주십시오.
 4. 설치전 실내보수 공간과 배관설치, 환기, 분진에 대해 면밀히 검토 후 설치위치를 결정하여 주십시오. (정면 : 600mm이상, 우측·좌면·뒷면 : 700mm이상, 천정 : 1200mm이상)
 5. 전기 배선의 세부사항은 취급설명서를 참조하여 주십시오.

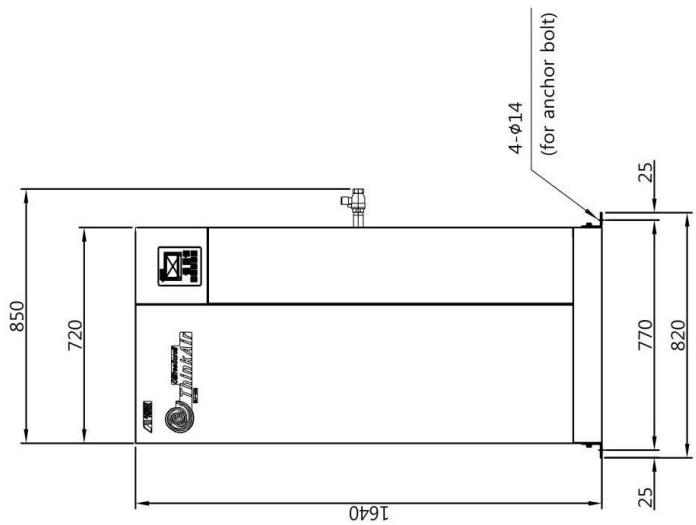
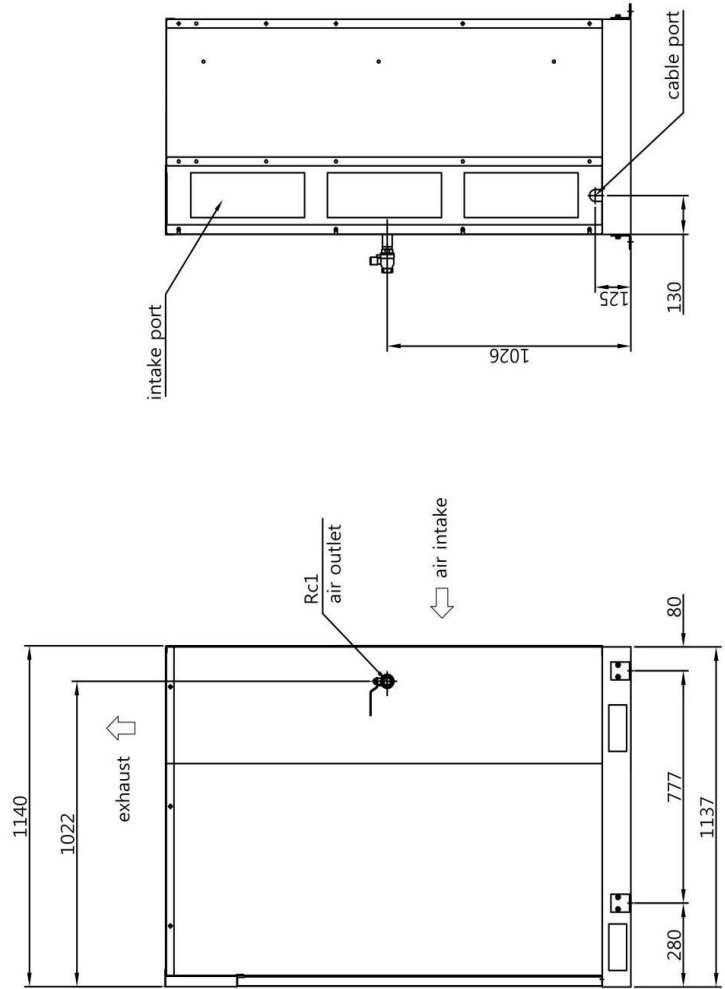
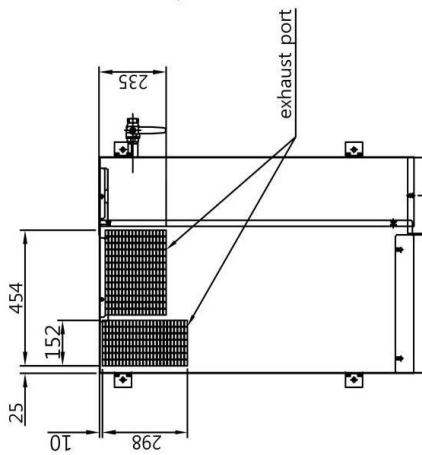

Product Name

Oil-Free Scroll Air Compressor

Model

SLPS-150B

REV. 0

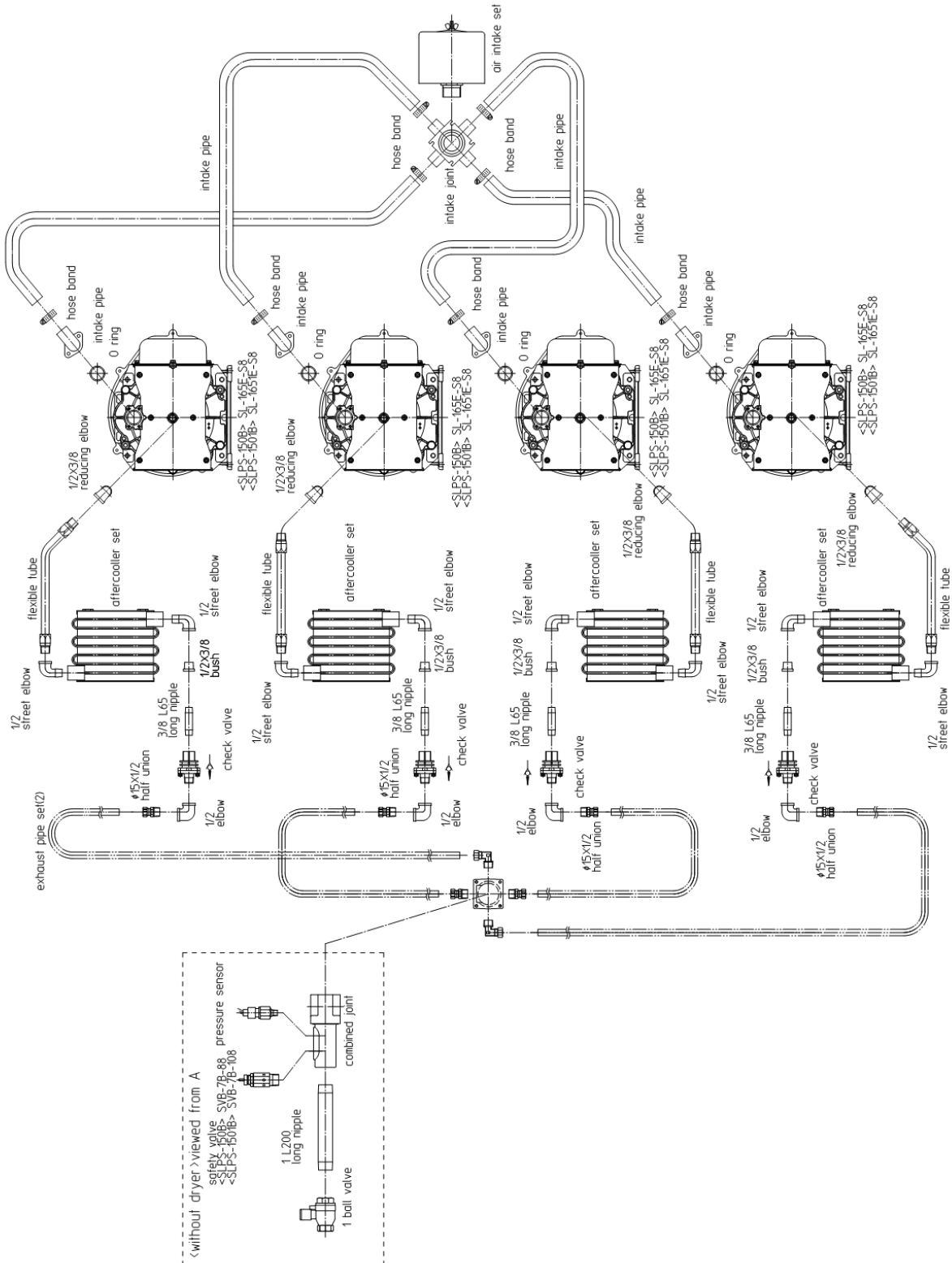

Product Name

Oil-Free Scroll Air Compressor

Model

SLPS-150B

REV. 0

TB2	terminal block
TRANS2	transformer
TB	terminal block
F	fuse
NF	noise filter
FAN1,2	ventilation fan
PS	pressure sensor
TH1~4	temperature sensor
OCR1~4	thermal relay
MCT~4	magnet contactor
MOTOR1~4	motor
TRANS	transformer for controller
MC	main controller
EMG. SW	emergency switch

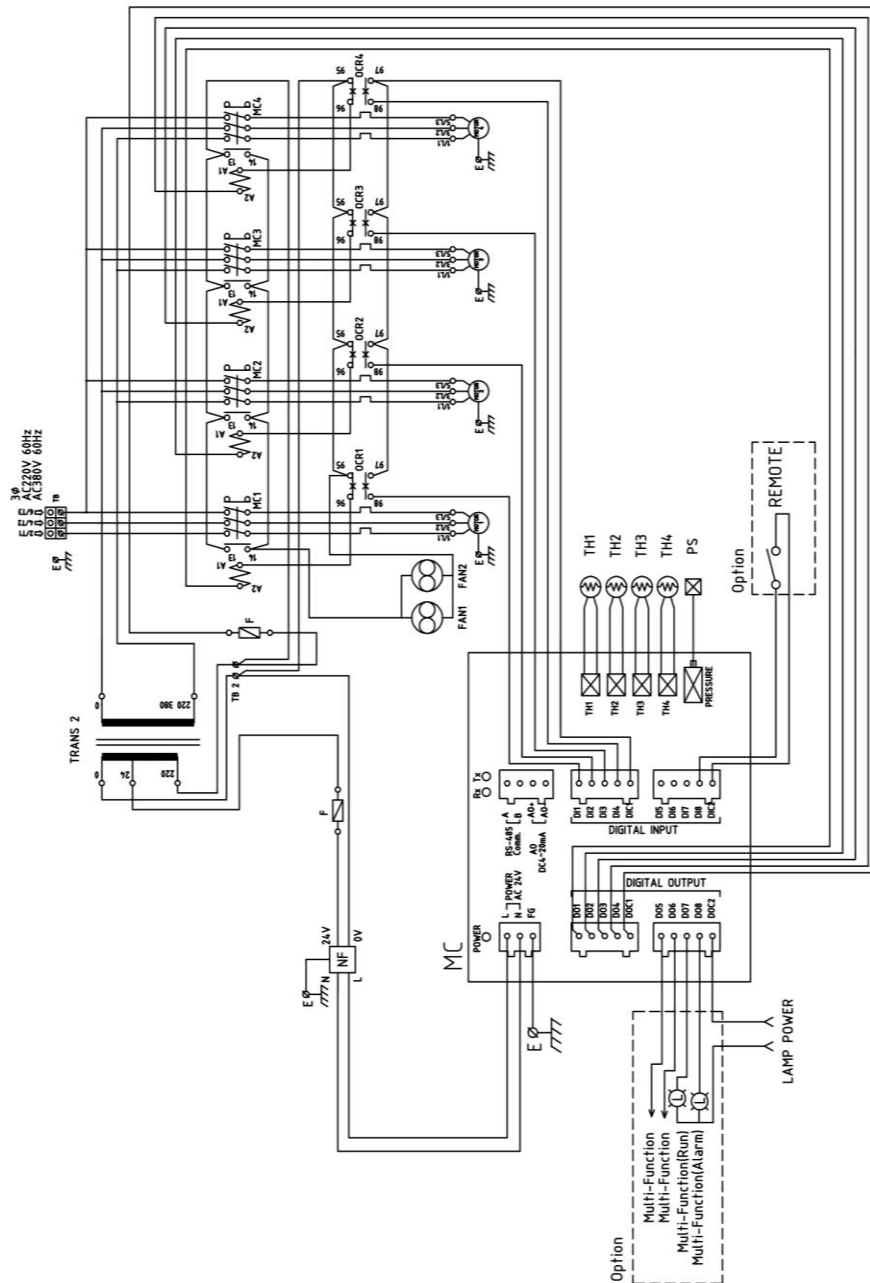

Product Name

Oil-Free Scroll Air Compressor

Model

SLPS-150B

REV. 0